

Balancing Valve

cim787CC.1

Variable Orifice with Integral Test Points - Copper x Copper

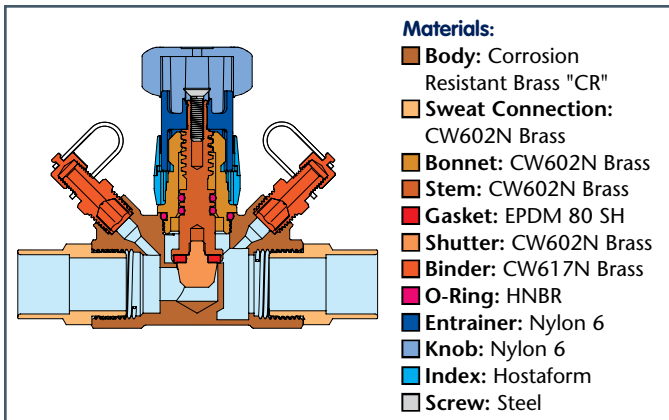

Applications:

The CIM 787CC.1 balancing valve is manufactured in accordance with EN ISO 9001 and is designed to provide flow balancing and measurement across all valve settings. The CIM 787CC.1 balancing valve is available in valve sizes from 1/2" through 2" and is manufactured of corrosion resistant brass. It is suitable for both heating (LPHW) and cooling applications at working pressures up to 290 PSI.

Features:

- A compact body design with integral test points.
- A thread locking mechanism designed to accurately lock valve settings enabling the valve to be closed and re-opened to its exact pre-set position.
- Allen key valve position locking.
- Heat and impact resistant nylon handle with a 360° re-settable index collar and indicator scale which can be read from any angle.
- An EPDM lined valve plug designed to provide increased control and tight shut-off for isolation purposes.

The CIM 787CC.1 balancing valve has been tested by BSRIA with water containing high air and dirt levels. Testing results demonstrated an excellent tolerance to such conditions providing confidence that the valves will retain a high level of accuracy and repeatability of flow measurement under even the worst system conditions.

Connection:

Sweat connection.

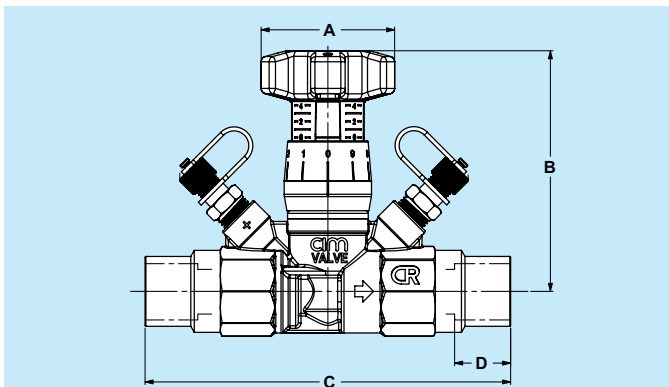

Size	1/2"	3/4"	1"	1-1/4"	1-1/2"	2"
A	1-15/16" 50mm	1-15/16" 50mm	1-15/16" 50mm	1-15/16" 50mm	1-15/16" 50mm	1-15/16" 50mm
B	3-7/16" 87.5mm	3-1/2" 89.5mm	3-5/8" 91.5mm	3-7/8" 99mm	3-7/8" 99mm	3-15/16" 100mm
C	4-5/8" 117mm	5-3/8" 136mm	6-3/16" 157mm	6-15/16" 177mm	7-9/16" 192mm	5-5/16" 211mm
D	1/2" 13mm	3/4" 19.5mm	15/16" 23.8mm	1" 25mm	1-1/8" 28mm	1-5/16" 34mm
Pounds	1.08	1.32	1.76	2.89	3.51	4.63
Grams	490	600	800	1310	1590	2100

Size	Fast Order No.	Technical ID No.
1/2"	787CC-04	CIM787CC-C04HBV
3/4"	787CC-06	CIM787CC-C06HBV
1"	787CC-07	CIM787CC-C07HBV
1-1/4"	787CC-08	CIM787CC-C08HBV
1-1/2"	787CC-09	CIM787CC-C09HBV
2"	787CC-10	CIM787CC-C10HBV

All Cimberio valves qualify for the American Recovery and Reinvestment Act and the Buy American Act.

Balancing Valve

cim787CC.1

PRESSURE SIGNAL

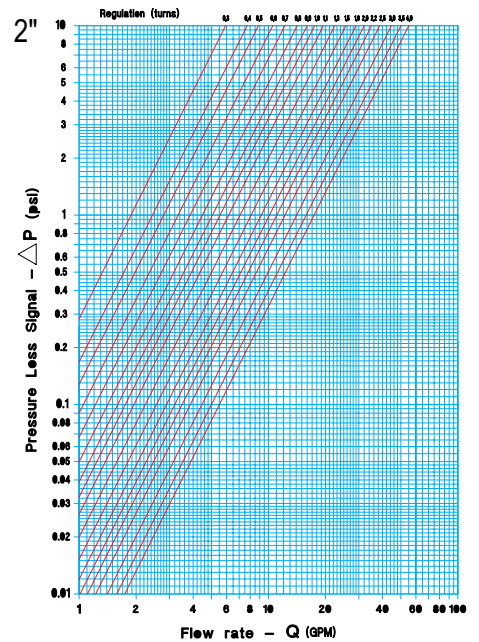
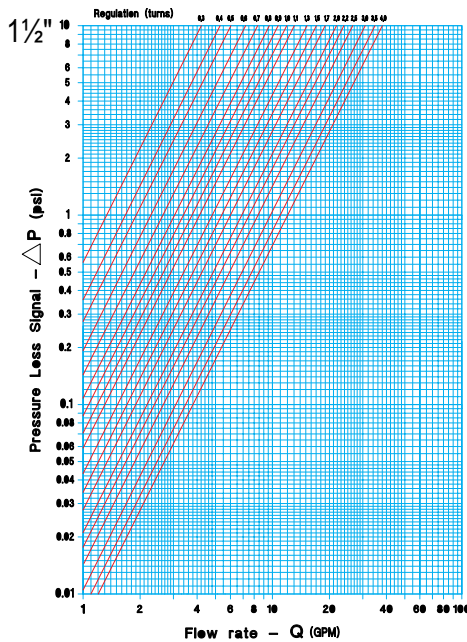
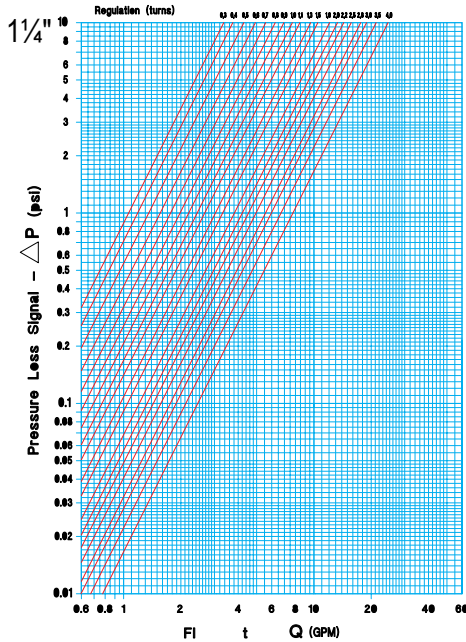
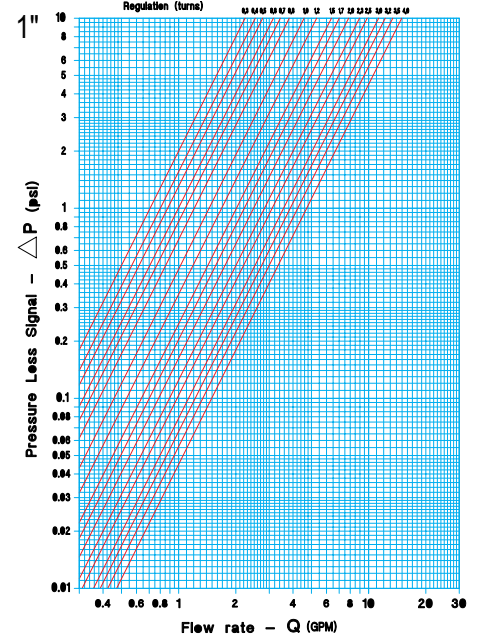
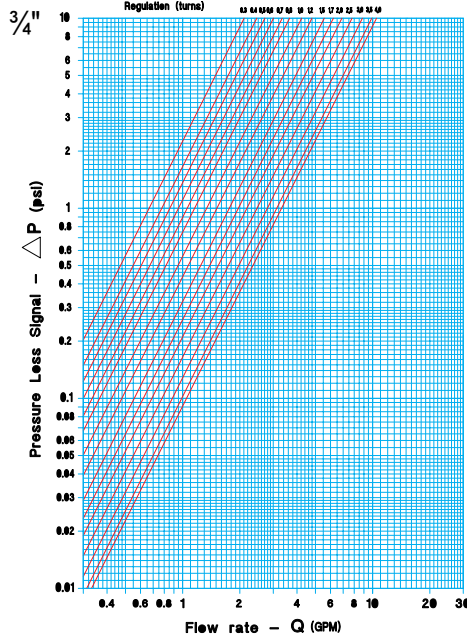
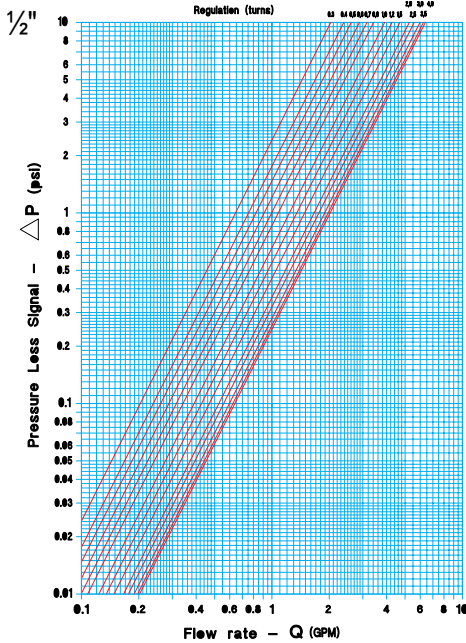

PRESSURE/TEMPERATURE RATINGS

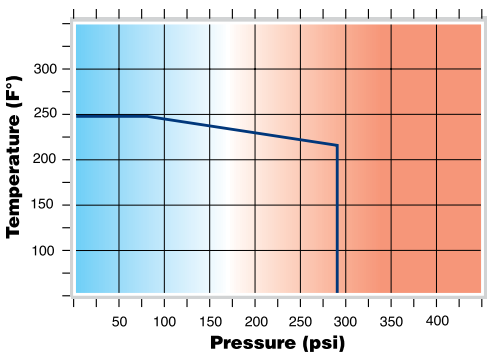

Working Pressure:
290 PSI

Maximum Operating Temperature:
Working Limit for Fluids
14° F – 248° F

Test Pressures:
According to ISO 5208

CV

CV: Capacity in "U.S. gal/min" at pressure drop of "1 PSI"
Element: Water - Temperature: 59.9° F

787CC.1 SIZE	1/2"	3/4"	1"	1-1/4"	1-1/2"	2"
CV	2.02	3.32	4.72	7.75	12.03	17.41